





36 707 892



- Ausladung 160 mm
- starrer Auslauf
- runder luftangereicherter Strahl
- Bohrungsdurchmesser Seitenventil 40 mm
- Bohrungsdurchmesser Auslauf 40 mm
- Rosetten Ø 55 mm
- Durchfluss max. 7 l/min
- bleifrei
- Dieses Produkt leistet einen Beitrag zur Erfüllung der Vorgaben von nachhaltigen Gebäudezertifizierungen, z.B. LEED®, BREEAM®, DGNB

	Platin gebürstet	36 707 892-06
	Chrom	36 707 892-00
	Platin	36 707 892-08
	Dark Chrome	36 707 892-19
	Messing gebürstet (23kt Gold)	36 707 892-28
	Schwarz matt	36 707 892-33
	Champagne gebürstet (22kt Gold)	36 707 892-46
	Champagne (22kt Gold)	36 707 892-47
	Chrom gebürstet	36 707 892-93
	Dark Platinum gebürstet	36 707 892-99

Benötigtes Zubehör



- UP-Wandbatterie Auslauf mittig -** 35 700 970 90
- Max. Einbautiefe 145 mm
 - Min. Einbautiefe 85 mm

Benötigtes Zubehör



- UP-Wandbatterie variable Positionierung -** 35 720 970 90
- Min. Einbautiefe 85 mm
 - Max. Einbautiefe 145 mm

36 707 892

mm [inches]

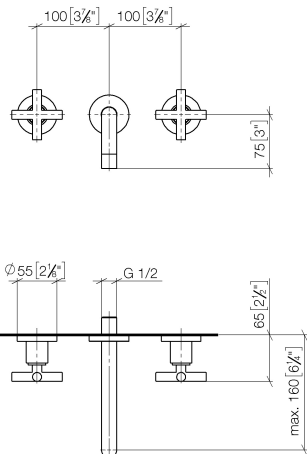

Durchflussdiagramm

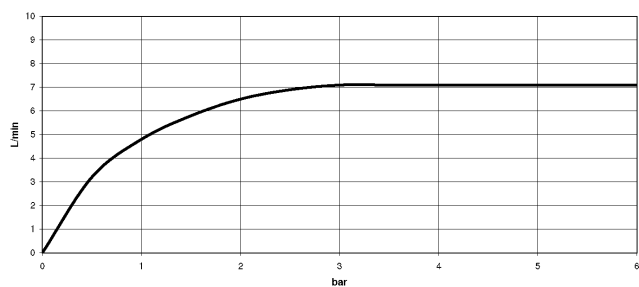

Zertifikate

WRAS_2107049. LGA_18937. ACS_20 ACC LY 741. ETA_19023.

36 707 892

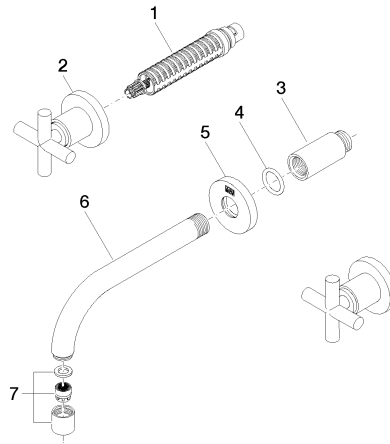

Ersatzteilstückliste

Nr.	Artikelnummer	Benennung	Verbaumenge	Lieferzeit
1	90 90 03 157 00 90	Oberteil	2	2
2	36 310 892-06	Anschluss	2	10
3	09 24 03 081 10 90	Verlaengerung	1	2
4	90 14 10 026 00 90	Dichtung	1	2
5	09 27 22 503-06	Rosette	1	10
6	04 28 22 089 10-06	Auslauf	1	10
7	90 23 01 019 00-06	Luftsprudler	1	10